



Mobile Column Lift Model Sets

MSC-18K-X-236, MSC-18K-X-472 & MSC-18K-X-6108

Capacity 18,000lbs / Each Column

Installation - Operation – Service Manual



IMPORTANT!!
**READ MANUAL THOROUGHLY BEFORE INSTALLING, OPERATING, SERVICING
OR MAINTAINING LIFT**

INDEX

PREFACE-----	PAGE 2
PRODUCT IDENTIFICATION-----	PAGE 2
OWNER / EMPLOYER OBLIGATIONS-----	PAGE 3
IMPORTANT SAFETY INSTRUCTIONS-----	PAGE 4
LOCATION-----	PAGE 7
GENERAL INFORMATION -----	PAGE 9
SET-UP / INSTALLATION -----	PAGE 10
SYSTEM TESTING BEFORE ACTUAL USE-----	PAGE 15
LIFTING OPERATION-----	PAGE 20
MAINTENANCE INSTRUCTIONS -----	PAGE 21
SERVICE -----	PAGE 22
SYSTEM DIAGNOSTIC MESSAGES -----	PAGE 24
EMERGENCY LOWERING PROCEDURE-----	PAGE 25
EXPLODED VIEWS & PARTS LISTS -----	PAGE 26
LIMITED WARRANTY -----	PAGE 34

PREFACE

Prior to the operation of your lift make sure that you have read the instructions thoroughly. These instructions are found in this manual. Please note that your warranty can be voided if you do not read the manual and understand its content.

If you have any questions, concerning operation, safety or application of your lift, please consult your distributor.

PRODUCT IDENTIFICATION

	
Lift Model:	<u>MSC-18K-X</u>
Serial No.:	<u>JAN 2018-XXXX</u>
Total Capacity:	<u>18,000 lbs. / Column</u>
Max. Arm Capacity:	<u>18,000 lbs.</u>
Date of Mfg.:	<u>JAN XX, XXXX</u>
Voltage: <u>120VAC</u> Amps: <u>15</u> Ph: <u>Single</u>	
Tuxedo Distributors, LLC. 8320 E Hwy 67, Alvarado, TX 76009 MADE IN CHINA	

OWNER / EMPLOYER OBLIGATIONS

1. The Owner/Employer shall ensure that lift operators are qualified and that they are trained in the safe use and operation of the lift using the manufacturer's operating instructions; ALI/SM10-1, **ALI Lifting it Right safety manual**; ALI/ST-10 **ALI Safety Tips card**; ANSI/ALI ALOIM-2008 (R2013), **American National Standard for Automotive Lifts - Safety Requirements for Operation, Inspection and Maintenance**; **ALI/WL400 Series, ALI Uniform Warning Label Decals/Placards**; and in the case of frame engaging lifts, ALI/LP-GUIDE, **Vehicle Lifting Points/Quick Reference Guide for Frame Engaging Lifts**.
2. The Owner/Employer shall establish procedures to periodically inspect the lift in accordance with the lift manufacturer's instructions or ANSI/ALI ALOIM-2008 (R2013), **American National Standard for Automotive Lifts - Safety Requirements for Operation, Inspection and Maintenance**; and the Employer shall ensure that the lift inspectors are qualified and that they are adequately trained in the inspection of the lift.
3. The Owner/Employer shall establish procedures to periodically maintain the lift in accordance with the lift manufacturer's instructions or ANSI/ALI ALOIM-2008 (R2013), **American National Standard for Automotive Lifts - Safety Requirements for Operation, Inspection and Maintenance**; and the Employer shall ensure that the lift maintenance personnel are qualified and that they are adequately trained in the maintenance of the lift.
4. The Owner/Employer shall maintain the periodic inspection and maintenance records recommended by the lift manufacturer's instructions or ANSI/ALI ALOIM-2008 (R2013), **American National Standard for Automotive Lifts - Safety Requirements for Operation, Inspection and Maintenance**.
5. The Owner/Employer shall display the lift manufacturer's operating instructions; ALI/SM 10-1, **ALI Lifting it Right safety manual**; ALI/ST-10 **ALI Safety Tips card**; ANSI/ALI ALOIM-2008 (R2013), **American National Standard for Automotive Lifts - Safety Requirements for Operation, Inspection and Maintenance**; **ALI/WL Series, ALI Uniform Warning Label Decals/Placards**; and in the case of frame engaging lifts, ALI/LP- GUIDE, **Vehicle Lifting Points/Quick Reference Guide for Frame Engaging Lifts** in a conspicuous location in the lift area convenient to the operator.

6. The Owner/Operator shall provide necessary lockout/tag out means for energy sources per ANSI Z244.1-1982 (R1993), **Safety Requirements for the Lockout/Tag out of Energy Sources**, before beginning any lift repairs and maintenance.
7. The Owner/Employer shall not modify the lift in any manner without the prior written consent of the manufacturer.

IMPORTANT SAFETY INSTRUCTIONS (SAVE THESE INSTRUCTIONS)

Please deliver this manual to the lift owner and/or operator along with all other documentation provided with the lift. Failure to operate this equipment as intended may cause injury or death.

When using this lift, basic safety precautions should always be followed, including the following:

1. Read all instructions in this manual and on the lift thoroughly before installing, operating, servicing or maintaining the lift.
2. Care must be taken as burns can occur from touching hot parts.
3. Do not operate equipment with a damaged cord or if the equipment has been dropped or damaged . until it has been examined by a qualified service person.
4. Do not let a cord hang over the edge of the table, bench, or counter or come in contact with hot manifolds or moving fan blades.
5. If an extension cord is necessary, a cord with a current rating equal to or more than that of the equipment should be used. Cords rated for less current than the equipment may overheat. Care should be taken to arrange the cord so that it will not be tripped over or pulled.
6. Always unplug equipment from electrical outlet when not in use. Never use the cord to pull the plug from the outlet. Grasp plug and pull to disconnect.
7. Let equipment cool completely before putting away. Loop cord loosely around equipment when storing.
8. To reduce the risk of fire, do not operate equipment in the vicinity of open containers of flammable liquids (gasoline).

9. Adequate ventilation should be provided when working on operating internal combustion engines.
10. Keep hair, loose clothing, fingers, and all parts of body away from moving parts.
11. To reduce the risk of electric shock, do not use on wet surfaces or expose to rain.
12. Use only as described in this manual. Use only manufacturer's recommended attachments.
13. **ALWAYS WEAR SAFETY GLASSES.** Everyday eyeglasses only have impact resistant lenses; they are not safety glasses.
14. Inspect lift daily. Do not operate if it malfunctions or problems have been encountered. Never operate lift if it has broken, damaged or worn parts.
15. Never attempt to overload the lift. The manufacturer's rated capacity is shown on the identification label on the power side column. Do not override the operating controls or the warranty will be void.
16. Only trained and authorized personnel should operate the lift. Do not allow customers or bystanders to operate the lift or be in the lift area.
17. Position the lift support pads to contact the vehicle manufacturer's recommended lifting points. Raise the lift until the pads contact the vehicle. Check pads for secure contact with the vehicle.
18. **CAUTION!** Never work under the lift unless the mechanical safety locks are engaged.
19. Note that the removal or installation of some vehicle parts may cause a critical load shift in the center of gravity and may cause the vehicle to become unstable. Refer to the vehicle manufacturer's service manual for recommended procedures.
20. Always keep the lift area free of obstruction and debris. Grease and oil spills should always be cleaned up immediately.
21. Never raise vehicle with passengers inside.
22. Before lowering check area for any obstructions.
23. Before removing the vehicle from the lift area, position the columns to prevent damage to the lift and /or vehicle.

24. Check and adjust if need the correct air pressure in all tires before lifting. Do not exceed tire load when raising vehicle.
25. DO NOT raise / lower only one side if a vehicle.
26. Lift only on same axle. Do not stagger between axles.
27. Do not drive over or pinch the electrical communication cables.
28. Do not remove hydraulic fittings while under pressure.
29. Check floor to ceiling height for clearance when vehicle is fully raised.
30. Use only qualified lift service personnel and genuine manufacturing parts to make repairs.

WARNING!! Failure by purchaser to provide the recommended mounting surface could result in unsatisfactory lift performance, property damage, or personal injury.

For additional safety instructions regarding lifting, lift types, warning labels, preparing to lift, vehicle spotting, vehicle lifting, maintaining load stability, emergency procedures, vehicle lowering, lift limitations, lift maintenance, good shop practices, installation, operator training and owner/employer responsibilities, please refer to Lifting It Right+(ALI/SM) and Safety Tips+(ALI/ST) and vehicle lift points for service garage lifting SAE J2184.

For additional instruction on general requirements for lift operation, please refer to Automotive Lift-Safety Requirements for Operation, Inspection and Maintenance+(ANSI/ALI ALOIM).

Installation shall be performed in accordance with ANSO/ALI ALIS, Safety Requirements for Installation and Service of Automotive Lifts.

LOCATION

This lift has been evaluated for **INDOOR USE ONLY** with an operating ambient temperature range of 5 - 40°C (41-104°F)



ATTENTION! This lift is intended for **indoor installation only**. It is prohibited to install this product outdoors. Operating environment temperature range should be 41 . 104 °F (5 . 40 °C). **Failure to adhere will result in decertification, loss of warranty, and possible damage to the equipment.**

NOTICE

If attachments, accessories, or configuration modifying components used on this lift are located in the load path and affect operation of the lift, affect the lift electrical listing, or affect intended vehicle accommodation; and if they are not certified for use on this lift, then the certification of this lift shall become null and void. Contact the participant for information pertaining to certified attachments, accessories, or configuration modifying components.

www.auolift.org

© 2011 by ALI, Inc. ALI/WLSIA01

SAFETY DECALS

These Decals Must Be Applied to Lift.

REFERENCE: AUTOMOTIVE LIFT INSTITUTE, Inc.

NOTICE If attachments, accessories, or configuration modifying components used on this lift are located in the load path and affect operation of the lift, affect the lift electrical listing, or affect intended vehicle accommodation; and if they are not certified for use on this lift, then the certification of this lift shall become null and void. Contact the participant for information pertaining to certified attachments, accessories, or configuration modifying components.

www.auoift.org © 2011 by ALI, Inc. ALI/WLSIA01

**Automotive Lift Institute, Inc.
WL400 Series Label Kit**

 <p>WARNING</p> <p>Clear area if vehicle is in danger of falling.</p>	 <p>WARNING</p> <p>Remain clear of lift when raising or lowering vehicle.</p>	 <p>NOTICE</p> <p>Read operating and safety manuals before using lift.</p>	 <p>NOTICE</p> <p>Proper maintenance and inspection is necessary for safe operation.</p>
 <p>WARNING</p> <p>Locate lift on firm, level surface, preferably concrete.</p>	 <p>WARNING</p> <p>Be sure intended lifts are moving together evenly.</p>	 <p>NOTICE</p> <p>Do not operate a damaged lift.</p>	<p>The messages and pictographs shown are generic in nature and are meant to generally represent hazards common to all automotive lifts regardless of specific style.</p> <p>Funding for the development and validation of these labels was provided by the Automotive Lift Institute, PO Box 85 Cortland, NY 13045.</p> <p>Replacement label sets may be obtained from the original lift manufacturer and ALI's member companies. They are protected by copyright.</p> <p>www.auoift.org</p> <p>©1982 by ALI, Inc. ALI/WLSIA01</p>
 <p>WARNING</p> <p>All lifting forks must properly engage vehicle tires or supports.</p>	 <p>WARNING</p> <p>Do not drive over or pinch electrical cables.</p>	 <p>CAUTION</p> <p>Lift to be used by trained operator only.</p>	 <p>CAUTION</p> <p>Authorized personnel only in lift area.</p>
 <p>WARNING</p> <p>Keep feet clear of lift while lowering.</p>	<p>The messages and pictographs shown are generic in nature and are meant to generally represent hazards common to all automotive lifts regardless of specific style.</p> <p>Funding for the development and validation of these labels was provided by the Automotive Lift Institute, PO Box 85 Cortland, NY 13045.</p> <p>Replacement label sets may be obtained from the original lift manufacturer and ALI's member companies. They are protected by copyright.</p> <p>www.auoift.org</p> <p>©1982 by ALI, Inc. ALI/WLSIA01</p>	 <p>CAUTION</p> <p>When moving lift, be careful to avoid tipping.</p>	 <p>CAUTION</p> <p>Check for overhead obstructions before raising vehicle.</p>
		<p>The messages and pictographs shown are generic in nature and are meant to generally represent hazards common to all automotive lifts regardless of specific style.</p> <p>Funding for the development and validation of these labels was provided by the Automotive Lift Institute, PO Box 85 Cortland, NY 13045.</p> <p>Replacement label sets may be obtained from the original lift manufacturer and ALI's member companies. They are protected by copyright.</p> <p>www.auoift.org</p> <p>©1982 by ALI, Inc. ALI/WLSIA01</p>	

NOTE: SOME IMAGES IN THIS MANUAL ARE GENERIC AND MAY NOT RESEMBLE THE LIFT YOU HAVE PURCHASED.

1. GENERAL INFORMATION

1.1 SPECIFICATIONS

Models #	MSC-18K-X-236, MSC-18K-X-472 & MSC-18K-X-6108
Capacity	18,000 lbs. / Each Column
Pressure Relief Valve	2,030 psi Sealed Ex-Works
Pump motor	4HP (3Kw, DC24V, Max 125 Amp) / Each Column
Battery charger power supply	Input: 100-140VAC, 60Hz, Single Phase Output: 24VDC, Max 15 Amp
Operational Voltage	24 VDC
Lifting Height	67.1"
Column L / W / H	56.9" / 44.1" / 88.6" (Max Ht. 155.5")
Fork Adjustable Range	12.6" - 22"
Fork length	17.9"
Lifting / Lowering Time	100 sec / 60 sec at load of 18,000 lbs / each column
Noise Level	Max. 70 dB(A)
Set-up	Indoors
Unit Weight	1,548 lbs. per Column
Maximum Distance between Columns	32.8'
Min. Concrete Surface Strength	3000 Psi

2. SET-UP / INSTALLATION

Remark: Only move the lifting column with the **forklift**. Only raise the lifting column at the correct points. Damage to lifting column and /or injury to persons may occur if the lifting column is not moved in the correct manner.

2.1 PACKING LIST

The complete lift is a set of either two (2), four (4) or six (6) mobile column lifting units and one (1) parts box, based on model type.

1. Each column is a self-contained unit.
2. The parts box contains: (Based on Model Type)
 - a) Either - One (1), Three (3) or Five (5) Communication Cable Reels.
 - b) Either - Eight (8), Sixteen (16) or twenty-four (24) Battery Clamps.
 - c) Either . One (1), Two (2) or Three (3) Sets of Combined Seal Washers and Filter Meshes.
 - d) One (1) spare Electro-Magnetic Valve.
 - e) One (1) spare T-Connector.
 - f) Two (2) Keys for Column Door Interlock.
 - g) One (1) Magnet Ring. (Emergency Lowering Procedure)

Important document packet that includes, Installation, Operation and Maintenance Manual, ALI Manual, %Lifting it Right+, Automotive Lift Safety Tips Placard, ALI %Lifting Points Guide+, ANSI/ALI ALOIM:2008(R2013) Safety Requirements for Operation, Inspection and Maintenance.

Warranty Statement and Warranty Registration Instructions.

2.2 INSTALLATION REQUIREMENTS AND TOOLS / SUPPLIES

Foundation

Important: It is the user's responsibility to provide a satisfactory installation area for the lift. Lifts should only be installed on level concrete floors with a minimum thickness of four inches and half (4.5") or 114 mm. Concrete must have a minimum strength of 3000 psi and should be aged thirty (30) days prior to installation. Please consult an architect, contractor or engineer if doubt exists as to the strength and feasibility of the floor to enable proper lift installation and operation. **Do not use on asphalt.** Do not use on a suspended floor without approval from a licensed structural engineer.

A qualified person should be consulted to address seismic loads and other local or state requirements.

It is the user's responsibility to provide all wiring for electrical hook-up prior to installation and to insure that the electrical installation conforms to local building codes. Where required, it is the user's responsibility to provide an electrical isolation switch located in close proximity to the lift that will enable emergency stop capability and isolate electrical power from the lift for any servicing requirements.

Tools / Supplies

1. Cutting device to remove packaging.
2. Metric wrenches.
3. Allen wrenches.
4. Philips screw drivers.
5. Clean funnel for adding hydraulic oil.
6. Clean new * AW-32 Hydraulic Oil

(Hydraulic Oil needed per column 3.6 Gallons / 13.5 Liters)

***Note: Use only new fresh clean AW-32 Hydraulic Oil. The use of transmission fluids will void the lift warranty.**

NOTE: MSC-18K-X Lifts are NOT supplied with Batteries.

Customer must supply Batteries as recommended on Page 14.

Installation Instructions

When the lift arrives on site:

Check for any freight damages. The shipment should be thoroughly inspected as soon as it is received. The signed bill of lading is acknowledgement by the carrier of receipt in good condition of shipment covered by our invoice. If any of the goods called for on your bill of lading are shorted or damaged, do not accept them until the carrier makes a notation on the freight bill of the missing or damaged goods. Do this for your own protection. Check the contents of the accessory and hardware boxes to make sure no parts are missing.

NOTE: IT IS DIFFICULT TO COLLECT FOR LOSS OR DAMAGE AFTER YOU HAVE GIVEN THE CARRIER A CLEAR RECEIPT. THE LIFT MANUFACTURER IS NOT RESPONSIBLE FOR ANY FREIGHT DAMAGE.

2.3 UNPACKING AND HANDLING THE LIFTING COLUMN

Unpacking Procedure

- Remove all plastic wrap and cardboard. Be careful not to cut into the lower hydraulic hoses and fittings or to scratch the paint or damage the safety decals.
- Carefully open the parts box, avoid cutting the enclosed communication cables.
- Take out all of the cable reels, battery clamps, spare parts and document packet.

Preparing Lift for Initial Startup

To transport the columns to a location within the service facility for setup, please use the pallet jack attached to the column. Each column can be easily moved by lifting up and holding the lever on the handle, by raising up & lowering down the pallet jack handle in a pumping motion, 3-5 times until the column's central base is lifted from the floor. You can now maneuver the lift columns to any location by pulling the pallet jack handle to the desired location. Once you release the lever on the pallet jack handle, the column will lower down to the ground. **The lift shall not be operated unless the column is fully lowered to the ground.**

Filling the tank with hydraulic oil after the lower column cover is opened and the red plug on the motor pump tank is removed. Use a clean funnel and add new hydraulic oil (AW-32) into the tank. The oil level shall meet the indicating label on the tank. The approx. amount of oil per tank is 3.6Gal / 13.5 Liter.

After finished, reinstall the red plug back to the top of the tank. Close motor pump cover and secure with bolts.

Note: *The hydraulic system was tested during manufacturing. Each hydraulic cylinder and the power unit tank was filled and cycled to test for leaks and for performance. During this process the hydraulic cylinders were bleed to remove any air. The hydraulic oil was removed from the tank after testing. Because residual oil at the bottom of the tank and inside the cylinder remain, additional hydraulic system bleeding is not necessary.*

To install the batteries, first take away the battery covers on both sides of each column. After the battery is positioned, secure it with the battery clamps provided. Then connect the power cables to the battery terminals. Repeat for other side.

Note: *Ensure to correctly connect terminals: Red/Pos. = (+), Black/Neg. = (-)*

To charge the battery, if necessary. A battery charger is built into each column. Plug the battery charger power supply cord into a 110 volt grounded electrical outlet. Charge each mobile column lifts using a separate electrical outlet. Best performance will be obtained by charging all mobile column batteries at the same time. While charging, the red CHARGING lamp will be lighted. After the batteries are fully charged (about 10 hours), this red lamp will be off and the green FINISHED lamp will be lighted

When the lifts are new, charge the batteries for the first time approx. 12-15 hours or until the charging indicator light turns green. Battery charging after 20-30 cycles will typically take 6-8 hours. When the batteries are fully charged, disconnect the electrical cable and store in the charger bay.

To install the communication cable reels, first insert the reel holding frame into the base on the upper cover of the column. Then fix the reel on the base by screws. Plug the communication cable end into the socket on that specific column.

Please Note the Important Safety Information below for use of Extension Cords:

An extension cord should not be used unless absolutely necessary. Use of improper extension cords could result in a risk of fire or electric shock. If extension cords must be used, make sure the following safety precautions are observed.

- That the pins of plug of the extension cord are the same number, size and shape of those of the plug on the battery charger.
- That the extension cord is properly wired and in good electrical condition.
- That the wire in the extension cord is proper size as recommend below.

Minimum recommended wire size for various length extension cords used with each battery charger:

Length of Cord	25'	50'	100'
Cord Gauge	16 Gauge	14 Gauge	12 Gauge

- Do not operate the battery charger with a damaged cord or plug.
- Do not operate the battery charger if it has received a sharp blow, been dropped or otherwise damaged in any way.
- Do not disassemble the charger. Incorrect reassembly may result in a risk of electric shock or fire.
- To reduce the risk of electric shock, unplug the charger from outlet before attempting any maintenance or cleaning. Disconnecting the leads will not reduce this risk.
- To reduce the risk of shock or spark, never touch the ring terminals together while the charger is plugged into an outlet or extension cord.
- External connections to the battery charger shall comply with all local, state, and federal regulations.

WARNING

RISK OF EXPLOSIVE GASES

WORKING IN THE VICINITY OF A LEAD ACID BATTERY IS DANGEROUS. BATTERIES CONTAIN SULFURIC ACID AND PRODUCE EXPLOSIVE GASES. A BATTERY EXPLOSION COULD RESULT IN LOSS OF EYESIGHT OR SERIOUS BURNS. FOR THIS REASON, IT IS OF UTMOST IMPORTANCE THAT YOU FOLLOW THE INSTRUCTIONS EACH TIME YOU USE THE CHARGER.

TO REDUCE THE RISK OF BATTERY EXPLOSION, FOLLOW THESE INSTRUCTIONS AND THOSE PUBLISHED BY THE BATTERY MANUFACTURER FOR ANY EQUIPMENT YOU INTEND TO USE IN THE VICINITY OF THE BATTERY. REVIEW CAUTIONARY MARKINGS ON THESE PRODUCTS AND ON ENGINE, MOTOR OR OTHER EQUIPMENT REQUIRING BATTERY USAGE.

Battery Requirement Information:

- Battery Quantity: 2ea per MSC Column - (Not included with MSC-18K-X Lifts)
- Battery Type: 12VDC Sealed Deep Cycle Battery
- Battery Size: BCI Group 31
- Battery Capacity: 105 AH (Amp/Hour) @ 20 HR (Hour Rate)
- Battery Terminals: Threaded Stud Terminals

3. System testing before actual use

(Do not do any testing with a vehicle)

Familiarize yourself with the electronic controls and warning lights by reviewing the functions of each item listed below.

3.1 The Electronic Control Panels:

The electronic control system of MSC-18K-X includes one master and either one, three or five slave control panels, based on the model type. Each column has one height sensor, one motor pump, and one electromagnet safety latch.

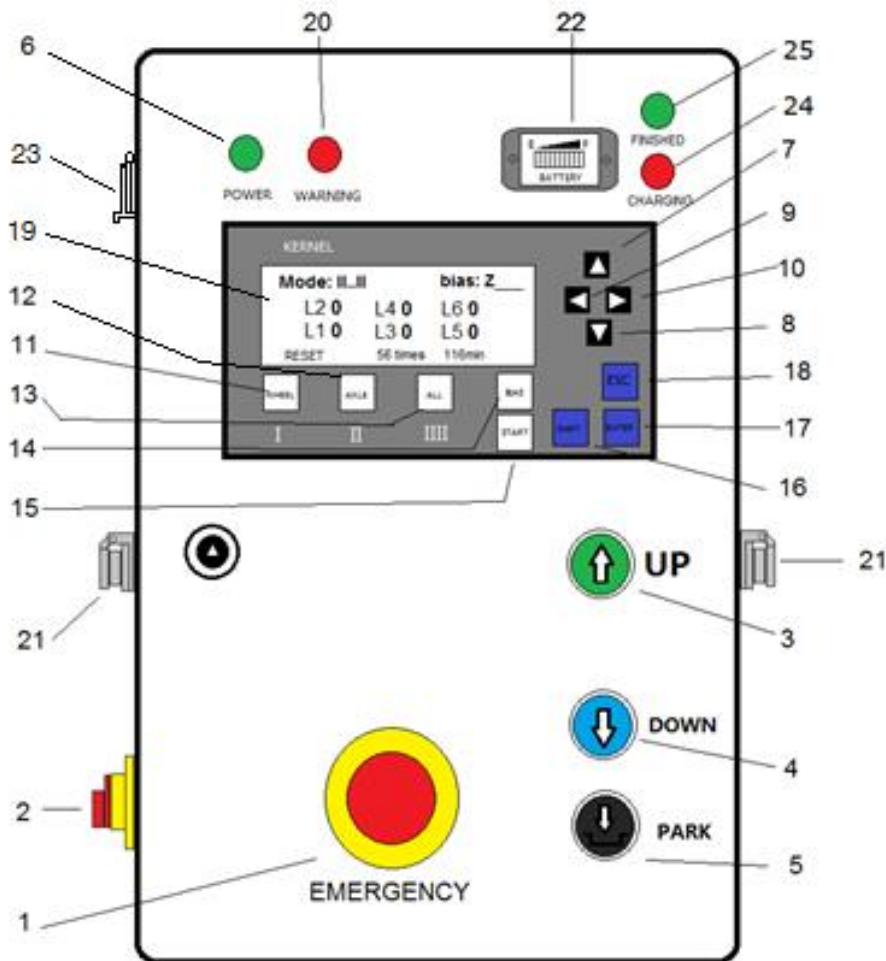

Main Control Panel - #1 Column

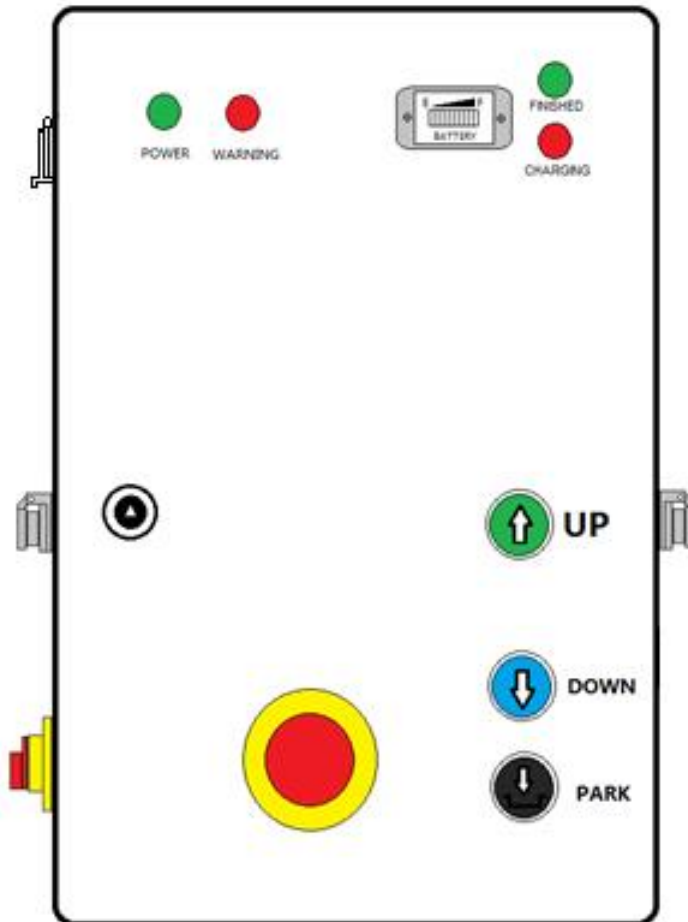

Sub Control Panels - #2, #3, #4, #5, #6 Columns

3.2 CONTROL PANEL DETAILS

1. EMERGENCY Button

To stop movements (lifting or lowering) immediately.

2. POWER Switch

Controls the power of the control panel or charging of the batteries.

3. '↑' (UP) Button

Controls the lifting of the columns.

4. '↓' (DOWN) Button

Controls the lowering of the columns.

5. '↓' (PARK) Button

Controls the locking of the columns.

6. POWER Light

This light will go on when the control panel is power on.

7. 8. 9. 10. CURSOR Buttons

These buttons move cursor on the screen to edit items.

11. 12. 13. MODE Buttons

To select between the functions: “**WHEEL**”, “**AXLE+& %ALL**”

14. BIAS Button

To set the zero point of height in initialization.

15. START Button

To start the running of the software.

16. SHIFT Button

This button is for the running of the program.

17. ENTER Button

This button serves confirming of instruction or entering sub menu.

18. ESC Button

Serves to enter or exit from menu; or from sub menu to upper lever menu.

19. LCD SCREEN

Display the height readings of columns & information

20. WARNING Light

This light will go on when the EMERGENCY button is pressed.

21. CABLE Port

This port is used for communication cable connection.

22. BATTERY Indicator

This indicator shows the output voltage of the batteries.

23. LED Light Socket

This socket provides the DC power for the LED light.

24. CHARGING Lamp

This is to indicate the batteries are in charging.

25. FINISHED Lamp

This is to indicate the batteries are fully charged.

Note:

Before turning on again the Power Switch, please wait for 20 seconds.

In “Axle” mode, are always paired as 1# & 2#, 3# & 4#, 5# & 6# per each vehicle axle.

In “ALL” mode, all columns move together.

In “Wheel” mode, each column moves individually.

*In case of emergency, push down the ‘**EMERGENCY**’ button to stop. If any motor does not stop, turn off the battery switch on column’s right side to make an immediate cease.*

3.3 COLUMN POSITIONS & CONNECTIONS

Depending on the model type, a full combination consists of either 2, 4 or 6 lifting columns. The position of the main column **1#** should be located opposite of column **2#** loading on the same axel of vehicle. The columns **3#** and **4#** shall be at wheels of the same axel. If required, the same will apply for columns **5#** and **6#**. (Figs. 3.3a, b, c)

Communication Cable

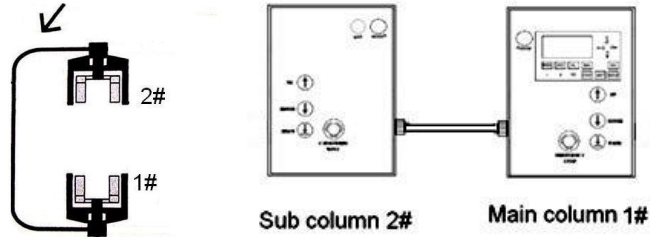

Fig. 3.3a (Two Column Configuration)

Communication Cable

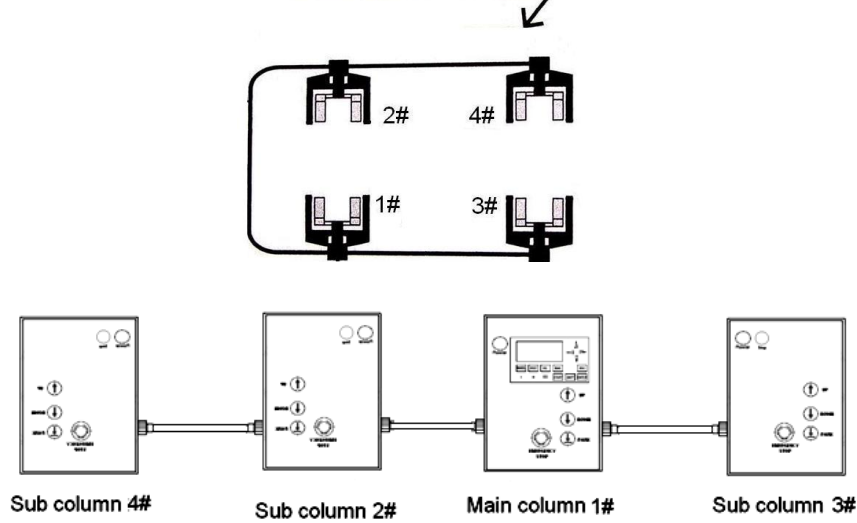

Fig. 3.3b (Four Column Configuration)

Communication Cable

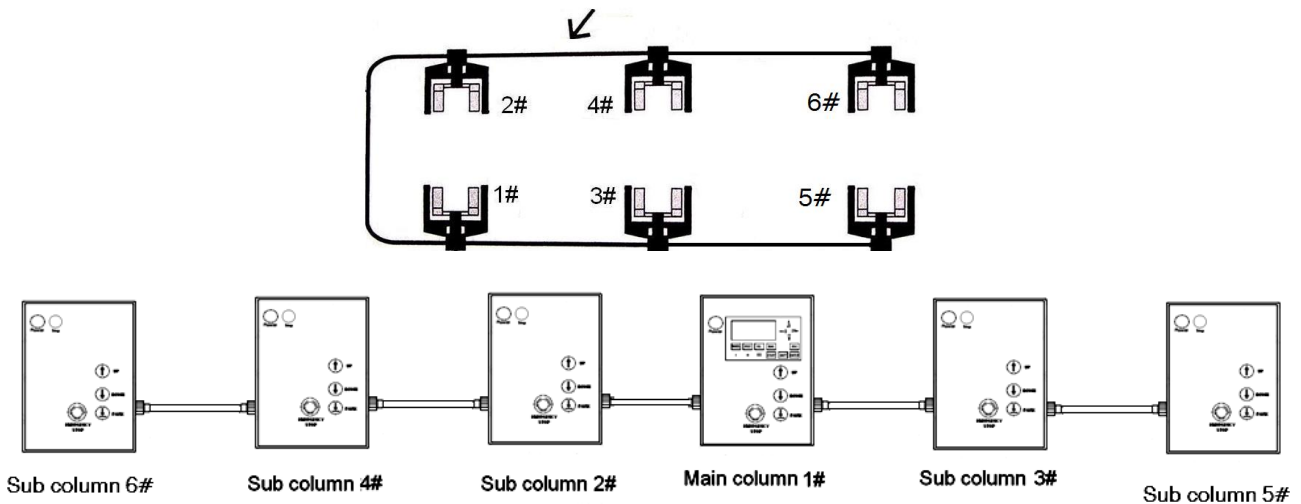

Fig. 3.3c (Six Column Configuration)

3.4 OPERATION TEST

The mobile column lifts are designed in such a way as to offer maximum flexibility and convenience. A lifting system can consist of 4 lifting columns.

The mobile column lifts are **set-up** as following:

1. Position the lifting columns as indicated in 3.3 (Fig. 3.3.)
2. Then turn on the battery power switch of each column on the side.
3. Set the control box power switch on each sub column to left position (ON) first, the green Power indicators will be on.
4. Then turn on the switch on main column to left (ON) and the LCD screen is lighted.
5. Wait until the LCD screen displays **Press START** then press the START button to start running of the software.
6. Take care that the emergency stop button of each lifting column must be released.

Unloaded Rise:

1. Press and hold the **UP**+button on the master 1# column panel, check if the carriages rise normally. Repeat to try the other columns in same way.
2. Press and hold the **UP**+button and allow the carriage to rise to its highest position. Check for any hydraulic leaks.

Emergency Stop:

1. Push down the red emergency button to stop the lifts while rising.
2. Turn red emergency button to release it after test.

Lower Down:

1. Press and hold the **DOWN**+button, the carriages will go up a little automatically to disengage the safety locks first, then go down.

Park:

1. Press and hold the **Park** button, the carriage will go down until the safety lock is engaged.

Mode 'Wheel' or 'Axle' test:

1. Press the button **Wheel** or **Axle** or **All** to change mode.
2. In **Wheel** mode, only that button pressed column will operate.
3. In **Axle** mode, only that button pressed pair columns will operate.

Note:

- a. ***In WHEEL or AXLE mode, the lifting or lowering will be carried out only 5 seconds per time.***
- b. ***In WHEEL or AXLE mode, the lifting or lowering will be stopped when the height difference between all columns or axles is greater than 2" (50 mm)***
- c. ***It is normal that during the moving process you may notice one or more columns slow or stop momentary. This occurs when the lift control system is synchronizing each column to maintain leveling.***

After you have read and understand all of the information in this manual and finished the operations testing you are ready to proceed to lifting vehicles. All technicians that will be using this equipment MUST read and understand all of the safety and operation items in this manual.

4. LIFTING OPERATION

4.1 Load a Vehicle:

1. Check and correct the tire pressure in each tire of the vehicle.
2. Position each mobile column adjacent to each tire on the vehicle. If the vehicle has dual rear axles position the mobile columns to use on the drive axle.

Note: *If an older vehicle has air bag suspension on the non-drive axles and mobile column are not used, extra support for the axles may be needed to prevent air bag damage. Consult with the vehicle manufacturer to determine if the air bag suspension has mechanical stops.*

3. Adjust the lifting arms so they are at the narrowest position that will allow the arms to position under the tires.
4. Move the lifting arms under the vehicle wheels then rest on ground.

Note: *Always maintain approx. 6 inches of clearance between the column top and the vehicle body.*

Note: *The lift shall not be operated until the columns are fully lowered off dolly wheels.*

4.2 Operation

5. Connect all communication cables as show in Fig. 3.3
6. Turn on all the battery switches on columns. Then turn on all the power switch with the master one in the last.
7. Depress the %UP+button and let columns rise approx. 6 inches. Release the %UP+button and inspect all of the columns to insure that the lifting arms are positioned properly.
8. Depress the %UP+button again and raise the vehicle to the desired height.

Note: *During the raising process you may notice one or more columns slow or stop lifting momentary. This occurs when the lift control system is synchronizing each column to maintain level lifting. This is normal.*

9. After reaching to the desired height, press the %BARK+button. All lift columns will lower to the first available safety lock position. When the lifts have settled onto the safety locks release the %lock+button. The vehicle is now safe and secured and ready for service.
10. To lower the lifts, check that all tools and equipment and has been removed from under the vehicle. Press and hold the %DOWN+button. The lift will rise for a few seconds to allow the safety lock disengaged. Then the lifts will lower down.
11. Before moving out the vehicle, move away all the columns from under the vehicle wheel first.
12. After finished one day's work, turn off the power switch, disconnect the communication cables, move the columns to the charging bay for charging.

5. Maintenance Instructions

CAUTION! If you are not familiar with vehicle lift maintenance, do not attempt repairs and contact the factory/distributor for assistance. Use only experienced lift service technicians to perform lift maintenance.

Daily:

- Check hydraulic system for leaks.
- Check the safety lock mechanism.
- Check communication cables for damage
- Inspect lifting arms to ensure they are in proper location & engaged in the locks.

Monthly:

- Test the emergency stop button on all columns. Columns should stop immediately.
- Check the battery charging cables and cable ends.
- Inspect communication cables and cable ends for wear or damage.
- Check oil levels in hydraulic pump tank. Add oil on necessary.

Annually:

- Have an ALI Certified Lift inspector check all of your vehicle lifts and the safety systems for wear or damage.

6. Service

CAUTION! If you are not familiar with vehicle lift service procedures, do not attempt repairs and contact the factory/distributor for assistance. Use only experienced lift service technicians to perform lift service.

Before and vehicle lift is serviced, follow the proper procedure for lock / out tag / out below.

Rules for Using Lockout Procedure

Use the Lockout Procedure whenever the lift is being repaired or serviced, waiting for repair when current operation could cause possible injury to personnel, or for any other situation when unintentional operation could injure personnel. No attempt shall be made to operate the lift when the energy isolating device is locked out.

Purpose

This procedure establishes the minimum requirements for the lockout of energy that could cause injury to personnel by the operation of lifts in need of repair or being serviced. All employees shall comply with this procedure.

Responsibility

The responsibility for assuring that this procedure is followed is binding upon all employees and service personnel from outside service companies (Installers, contactors, service repairmen). All employees shall be instructed in the safety significance of the lockout procedure by the facility owner/manager. Each new or transferred employee along with visiting outside service personnel shall be instructed by the owner/manager (or assigned designee) in the purpose and use of the lockout procedure

Preparation

Employees authorized to perform lockout shall ensure that the appropriate energy isolating device (circuit breaker, fuse, disconnect, etc.) is identified for the lift being locked out. Other such devices for other equipment may be located in close proximity of the appropriate energy isolating device. If the identity of the device is in question, see the shop supervisor for resolution. Assure that proper authorization is received prior to performing the lockout procedure.

Sequence of Lockout Procedure

Notify all affected employees that a lockout is being performed and the reason for it.

Unload the subject lift. Shut it down and assure the disconnect switch is "OFF" if one is provided on the lift.

The authorized lockout person operates the main energy isolation device removing power to the subject lift.

If this is a lockable device, the authorized lockout person places the assigned padlock on the device to prevent its unintentional reactivation. An appropriate tag is applied stating the person's name, at least 3"x 6" in size, an easily noticeable color, and states do not operate device or remove tag.

If this device is a non-lockable circuit breaker or fuse, replace with a "dummy" device and tag it appropriately as mentioned *above*.

Attempt to operate lift to assure the lockout is working. Be sure to return any switches to the "OFF" position.

The equipment is now locked out and ready for the required maintenance or service.

Restoring Equipment to Service

Assure the work on the lift is complete and the area is clear of tools, vehicles, and personnel.

At this point, the authorized person can remove the lock (or dummy circuit breaker or fuse) & tag and activate the energy isolating device so that the lift may again be placed into operation.

7. System Diagnostic Messages

The mobile column lifts have self-diagnostic systems that may display a fault message on the LCD screen. Most fault messages indicate some sort of operator error and are designed so the user can correct the most common operation mistakes without employing a service technician. Listed below are the most common fault messages.

	MESSAGE	EXPLANATION
1	PLC err, check & repower	<p>a. Communication between master and slave columns failed. (Bad cable connection, or PLC lack of power.)</p> <p>b. Some PLC not working</p> <p>Solution: System must be powered off for checking, then power on again</p>
2	Encode err, WHEEL/AXLE!	<p>Some encoder is not working (not powered, bad wired or in error)</p> <p>Solution: System must be power off for checking then power on again</p>
3	Asynch! WHEEL / AXLE mode	<p>a. Too big difference in height reading (>1700mm), caused by over turning</p> <p>b. Some column not move (motor not running, carriage locked)</p> <p>c. Some encoder not turning (belt left the gear)</p> <p>Solution: The height sensor (encoder) must be reset.</p>
4	24Vdc insufficient	<p>After moving stopped, one or more columns were found battery in low voltage. The lift will not raise up any more but may lower down.</p> <p>Solution: To System must be power off for checking then power on again</p>
5	Locked by abnormal ope.	<p>One button is pressed within 2qafter previous button is released.</p> <p>Solution: To press any button on other column control panel.</p>
6	Stop!	<p>a. Emergency button is pressed.</p> <p>b. Communication between columns is broken.</p> <p>c. One or more column is power off.</p> <p>d. Within 2 second after button is released.</p> <p>Solution: Waiting for 2 seconds.</p>
7	Manual adj.! Max. <5s / time	<p>Manually adjust column height. Maximum single operation for 5 seconds per time.</p> <p>Solution: Press more time for more movement.</p>
8	Reset! xx time xx min.	<p>RESET state: one lift height is below 5 cm when in ALL mode. Lift will be back in ZERO bias.</p> <p>Free movement is possible and pair of column can be added or taken away.</p> <p>Note: Any operation will leave this in RESET state.</p>
9	Reach end of travel	<p>One column stops after reaching its height limit. (this column will not raise when lower down)</p>
10	(Audible buzzing noise)	<p>The DC Motor incorporates a redundant Contactor, which if one fails a buzzing noise will indicate the fault, only when motor is not running. Lift can still operate using one Contactor.</p> <p>Solution: Contact dealer to replace defective Motor Contactor</p>

8. Emergency - Manual Lowering Procedure

WARNING!!

THIS PROCEDURE IS RECOMMENDED TO BE PERFORMED BY A QUALIFIED SERVICE PERSON AND/OR A FULLY TRAINED OPERATER

Note: Before performing this procedure, make sure there are no obstructions that will affect lowering down.

In case of an emergency or without power, please use the supplied magnet ring found in the parts box, to lower each column down manually. (Fig. 8.1)

1. Open the lower cabinet, by removing the screws to access the power unit.
2. Locate the solenoid valve coil on the right side of power unit's valve body, then loosen hex nut to remove the valve coil from the release valve.
3. Place the magnet ring on the release valve's stem. The release valve will open and the lift column will begin to lower down by gravity. (See Note below)

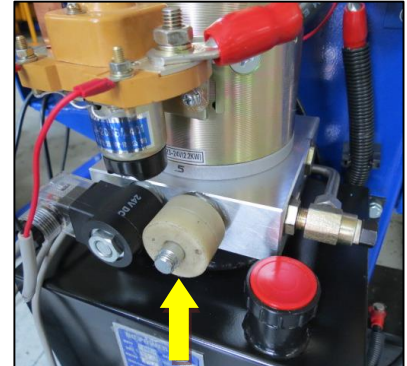

Fig. 8.1

Note: Before placing the magnet ring on release valve stem, ensure the safety latch is not in the locked position, located inside the upper cabinet.

4. Using the key provided to open the upper cabinet door (Fig. 8.2), locate the safety latch mechanism to ensure the safety latch is not in the locked position. (Fig 8.3).
5. If safety latch is in the locked position, pull the electro-magnet pin back by hand and hold to disengage the safety latch to lower. (Fig. 8.4)



Fig. 8.2

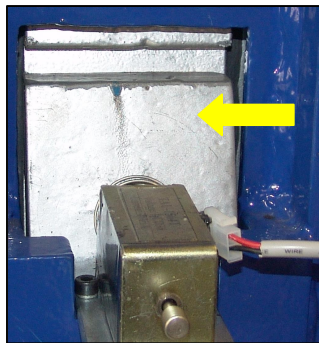

Fig. 8.3

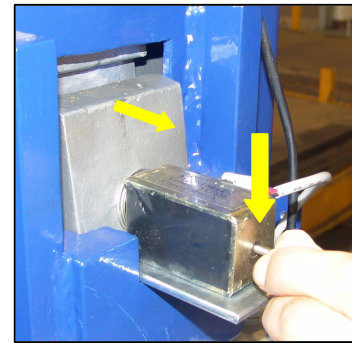

Fig. 8.4

Note: If a vehicle is loaded on the lift, columns can only be lowered down in 2" (5cm) increments each time, one after another, to keep the vehicle in a safe level position.

For procedure assistance, please contact the factory/distributor.

EXPLODED VIEWS & PARTS LISTS

Column Assembly

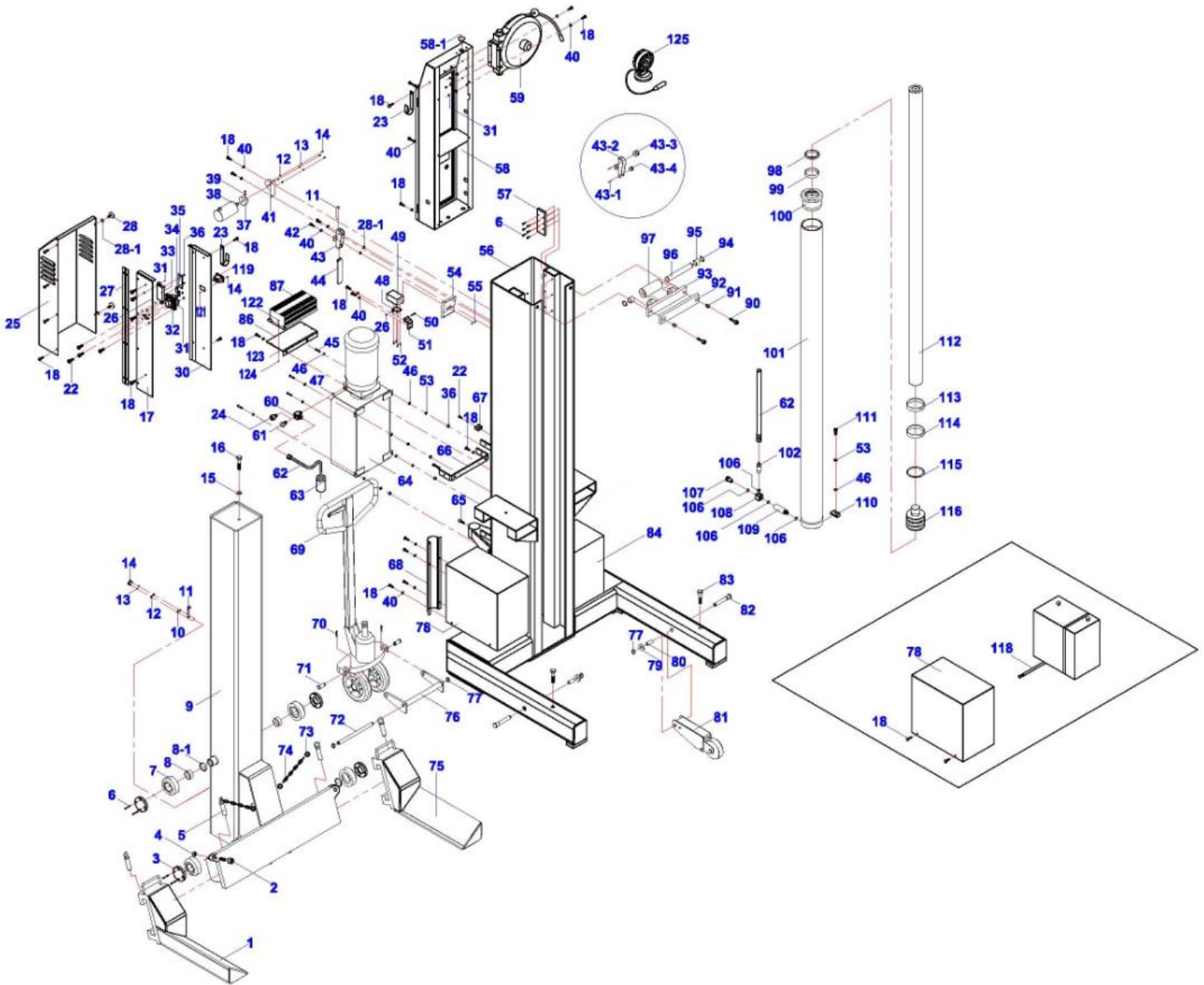

Drawing #1

Column Assembly Parts List

ITEM	Tux P/N	M-Ref P/N	DESCRIPTION	QTY
1	MSC-18KX-01-001	DJ02-04000-000	Right Fork	1
2	MSC-18KX-01-002	5102-12035-000	Bolt, M12 x 35mm	2
3	MSC-18KX-01-003	DJ02-02003-000	Nylon Slider	2
4	MSC-18KX-01-004	5202-00012-000	Self-Lock Nut, M12	2
5	MSC-18KX-01-005	DJ02-00011-000	Pin	2
6	MSC-18KX-01-006	5114-05014-000	Socket Screw, M5 x 14mm	28
7	MSC-18KX-01-007	DJ02-02001-000	Roller	4
8	MSC-18KX-01-008	DJ02-02005-000	Copper Bushing	4
8-1	MSC-18KX-01-008.1	DJ02-02004-000	Washer	4
9	MSC-18KX-01-009	DJ02-02000-000	Carriage	1
10	MSC-18KX-01-010	DJ02-00021-000	Block Plate	1
11	MSC-18KX-01-011	DJ02-00017-000	Teeth Belt	1
12	MSC-18KX-01-012	5302-00004-000	Flat Washer, D4	9
13	MSC-18KX-01-013	5306-00004-000	Elastic Washer, D4	5
14	MSC-18KX-01-014	5110-04010-000	Screw, M4 x 10mm	8
15	MSC-18KX-01-015	5302-00010-000	Flat Washer, D10	7
16	MSC-18KX-01-016	5102-10035-000	Bolt, M10 x 35mm	1
17	MSC-18KX-01-017	DJ02-19003-M00	Right Side Plate	1
18	MSC-18KX-01-018	5115-06012-000	Screw, M6 x 12mm	42
22	MSC-18KX-01-022	5110-05014-000	Screw, M5 x 14mm	9
23	MSC-18KX-01-023	DJ02-00034-000	Small Hook	2
24	MSC-18KX-01-024	SJ03-14002-000	Fitting	1
25	MSC-18KX-01-025	DJ02-19001-000	Cover	1
26	MSC-18KX-01-026	5206-00005-000	Self-Lock Nut, M5	1
27	MSC-18KX-01-027	DJ02-19002-000	Hinge	1
28	MSC-18KX-01-028	5116-06012-000	Hand Screw, M6 x 12mm	2
28-1	MSC-18KX-01-028.1	DJ02-00039-000	Nylon Washer	4
30	MSC-18KX-01-030	DJ02-19100-A00	Left Side Plate	1
31	MSC-18KX-01-031	5202-00006-000	Nut, M6	4
32	MSC-18KX-01-032	BZ22-05503-MET	Battery Switch	1
33	MSC-18KX-01-033	BZ22-05514-000	Fuse Case	1
34	MSC-18KX-01-034	BZ22-05516-000	Copper Plate	1
35	MSC-18KX-01-035	BZ22-05515-000	Fuse, 150A	1
36	MSC-18KX-01-036	5202-00008-000	Hex Nut, M8	4
37	MSC-18KX-01-037	DJ02-00019-000	Gear	1
38	MSC-18KX-01-038	DJ02-00016-000	Electro-Optical Encoder	1
39	MSC-18KX-01-039	5306-04005-000	Threaded Pin, M4 x 5mm	2
40	MSC-18KX-01-040	5306-00006-000	Spring Washer, D6	24
41	MSC-18K-01X-041	DJ02-00015-000	Support Board	1
42	MSC-18KX-01-042	5110-06020-000	Screw, M6 x 20mm	2
43	MSC-18KX-01-043	DJ02-11000-000	Wheel Support	1
43-1	MSC-18KX-01-043.1	DJ02-11003-000	Shaft	2
43-2	MSC-18KX-01-043.2	DJ02-11100-000	Roller Frame	1
43-3	MSC-18KX-01-043.3	DJ02-11001-000	Big Roller	1

43-4	MSC-18KX-01-043.4	DJ02-11002-000	Small Roller	1
44	MSC-18KX-01-044	DJ02-00018-000	Weight Bar	1
45	MSC-18KX-01-045	5102-08020-000	Bolt, M8 x 20mm	4
46	MSC-18KX-01-046	5302-00008-000	Flat Washer, D8	8
47	MSC-18KX-01-047	5901-00010-000	O-Ring, D10 x 2.4	1
48	MSC-18KX-01-048	DJ02-00004-000	Coil Support Board	1
49	MSC-18KX-01-049	DJ02-00006-000	Electro-Magnet	1
50	MSC-18KX-01-050	5102-05040-000	Bolt, M5 x 40mm	1
51	MSC-18KX-01-051	DJ02-00031-000	Coil Fixing Board	1
52	MSC-18KX-01-052	5107-03010-000	Screw, M3 x 10mm	4
53	MSC-18KX-01-053	5306-00008-000	Spring Washer, D8	5
54	MSC-18KX-01-054	DJ02-00008-000	Lock Tongue	1
55	MSC-18KX-01-055	5402-04030-000	Cotter Pin, D4 x 30mm	1
56	MSC-18KX-01-056	DJ02-01000-MET	Column	1
57	MSC-18KX-01-057	DJ02-00007-000	Slip Plate	2
58	MSC-18KX-01-058	QK02-11000-MET	Control Box	1
58-1	MSC-18KX-01-058.1	DJ02-00007-A00	Cover, HP-22	1
59	MSC-18KX-01-059	QK04-00100-M00	Cable Reel	1
60	MSC-18KX-01-060	SJ03-14001-000	T-Fitting	1
61	MSC-18KX-01-061	SJ03-14005-000	Close Nut	1
62	MSC-18KX-01-062	DJ02-12000-000	Oil Pipe	1
63	MSC-18KX-01-063	DJ02-00030-000	Rubber Ring	1
64	MSC-18KX-01-064	DJ02-13000-000	Motor Pump	1
65	MSC-18KX-01-065	5102-10020-000	Hex Screw, M10 x 20mm	1
66	MSC-18KX-01-066	DJ02-00033-000	Cover Support	2
67	MSC-18KX-01-067	BZ22-05511-000	Pipe Fixing Frame	1
68	MSC-18KX-01-068	DJ02-00029-000	Pipe Cover	1
69	MSC-18KX-01-069	DJ02-11000-000	Trolley	1
70	MSC-18KX-01-070	5402-05030-000	Cotter Pin, D5 x 30mm	2
71	MSC-18KX-01-071	DJ02-00001-000	Pin	2
72	MSC-18KX-01-072	DJ02-00032-000	Shaft	1
73	MSC-18KX-01-073	DJ02-00010-000	Ring, D4 x D35	4
74	MSC-18KX-01-074	DJ02-00009-000	Chain	2
75	MSC-18KX-01-075	DJ02-03000-000	Left Fork	1
76	MSC-18KX-01-076	DJ02-17000-000	Connecting Frame	1
77	MSC-18KX-01-077	5304-00016-000	Circlip, D16	2
78	MSC-18KX-01-078	DJ02-00004-MET	Right, Battery Cover	1
79	MSC-18KX-01-079	5302-00016-000	Flat Washer, D16	2
80	MSC-18KX-01-080	DJ02-00014-000	Bushing	2
81	MSC-18KX-01-081	DJ02-06000-000	Front Wheel	2
82	MSC-18KX-01-082	DJ02-00013-000	Wheel Shaft	2
83	MSC-18KX-01-083	5102-16035-000	Hex Bolt, M16 x 35	2
84	MSC-18KX-01-084	DJ02-00003-MET	Left, Battery Cover	1
86	MSC-18KX-01-086	DJ02-00019-MET	Charger Board	1
87	MSC-18KX-01-087	BZ22-05509-MET	Battery Charger	1
88	MSC-18KX-01-088	DJ02-15000-000	Fork Pocket	2
89	MSC-18KX-01-089	5306-00010-000	Elastic Washer, D10	6

90	MSC-18KX-01-090	5102-14035-000	Socket Bolt, M14 x 35mm	2
91	MSC-18KX-01-091	DJ02-00036-000	Washer	2
92	MSC-18KX-01-092	DJ02-00035-000	Protecting Board	1
93	MSC-18KX-01-093	DJ02-10100-000	Roller Holder	1
94	MSC-18KX-01-094	5304-00025-000	Circlip, D25	2
95	MSC-18KX-01-095	DJ02-10102-002	Spacer	2
96	MSC-18KX-01-096	DJ02-10002-001	Shaft	1
97	MSC-18KX-01-097	DJ02-10001-000	Roller	1
98	MSC-18KX-01-098	5906-00070-000	Dust Ring, D70	1
99	MSC-18KX-01-099	DJ02-05005-000	Guide Belt - #2	1
100	MSC-18KX-01-100	DJ02-05004-000	Guide Ring	1
101	MSC-18KX-01-101	DJ02-05102-000	Cylinder Body	1
102	MSC-18KX-01-102	DJ02-09000-000	Safety Valve	1
106	MSC-18KX-01-106	DJ02-05007-000	Combined Washer	4
107	MSC-18KX-01-107	DJ02-05011-000	Oil Screw	1
108	MSC-18KX-01-108	DJ02-05010-000	Connector	1
109	MSC-18KX-01-109	DJ02-05008-000	Oil Fitting	1
110	MSC-18KX-01-110	DJ02-00027-000	Cylinder Fixing Board	1
111	MSC-18KX-01-111	5105-08025-000	Hex Screw, M8 x 25mm	1
112	MSC-18KX-01-112	DJ02-05003-000	Piston Rod	1
113	MSC-18KX-01-113	DJ02-05009-000	Position Bushing	1
114	MSC-18KX-01-114	DJ02-05002-000	Guide Belt - #1	2
115	MSC-18KX-01-115	5903-00795-000	Seal Ring	1
116	MSC-18KX-01-116	DJ02-05002-000	Piston	1
118	MSC-18KX-01-118	BZ22-00002-000	Hose Clamps	4
119	MSC-18KX-01-119	SL02-00041-A00	Socket	1
121	MSC-18KX-01-121	5206-00004-000	LED Lamp Socket, M4	2
122	MSC-18KX-01-122	5110-04010-000	Screw, M4 x 10mm	4
123	MSC-18KX-01-123	5302-00004-000	Flat Washer, D4	8
124	MSC-18KX-01-124	5206-00004-000	Lock Nut, M4	4
125	MSC-18KX-01-125	QK04-80001-FJ5	LED Lamp, 24VDC/27W	1

Control Panel Assembly

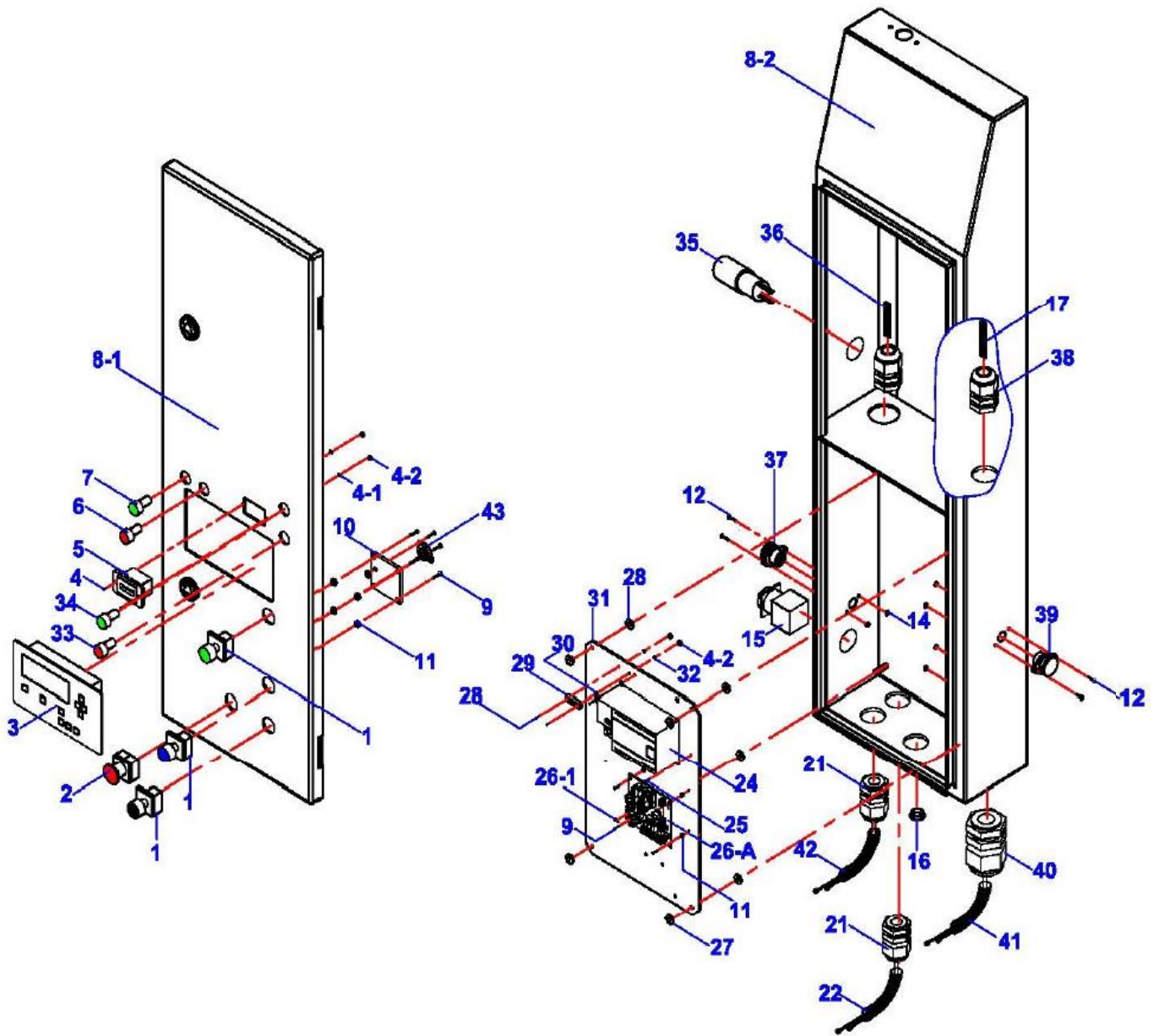

Drawing #2

Control Panel Assembly Parts List

ITEM	Tux P/N	M-Ref P/N	DESCRIPTION	QTY
1-1	MSC-18KX-02-001.1	DJ02-20002-000-Grn	Operation Button, Green	1
1-2	MSC-18KX-02-001.2	DJ02-20002-000-Blu	Operation Button, Blue	1
1-3	MSC-18KX-02-001.3	DJ02-20002-000-Blk	Operation Button, Black	1
2	MSC-18KX-02-002	DJ02-20003-000	Emergency Button, Red	1
3	MSC-18KX-02-003	DJ02-20010-000	Screen, Main	1
4	MSC-18KX-02-004	5110-00004-000	Screw, M4 x 12mm	2
4-1	MSC-18KX-02-004.1	5203-00004-000	Spring Washer, D4	2
4-2	MSC-18KX-02-004.2	5202-00004-000	Nut, M4	2
5	MSC-18KX-02-005	QK04-00012-000	Battery Meter Indicator	1
6	MSC-18KX-02-006	DJ02-20006-000	Red Lamp Indicator	1
7	MSC-18KX-02-007	DJ02-20005-000	Green Lamp Indicator	1
8-1	MSC-18KX-02-008.1	DJ03-13001-000	Main Panel (Sub)	1
8-2	MSC-18KX-02-008.2	QK02-11100-MET	Case	1
9	MSC-18KX-02-009	5110-03008-000	Bolt, M3 x 8mm	12
10	MSC-18KX-02-010	QK02-20200-L60	Connecting PCB	1
11	MSC-18KX-02-011	QK02-10013-000	Spacer, M3 x 10mm	8
12	MSC-18KX-02-012	5110-03015-000	Screw, M3 x 15mm	6
14	MSC-18KX-02-014	5202-00003-000	Nut, M3	6
15	MSC-18KX-02-015	DJ04-20001-100	Power Switch	1
16	MSC-18KX-02-016	QK04-00011-000	Plug Cover, D16	1
17	MSC-18KX-02-017	DJ02-00200-000	Coil Cable	1
21	MSC-18KX-02-021	DT01-06023-000	Cable Nut, M16	2
22	MSC-18KX-02-022	QK04-30300-000	Charger Cable, Red / Black	1
24-1	MSC-18KX-02-024.1	DJ02-10002-000M	PLC (Main)	1
24-2	MSC-18KX-02-024.2	DJ02-10002-000S	PLC (Sub)	1
25	MSC-18KX-02-025	DJ02-10032-000	Screw, 3.5 x 15mm	2
26-A	MSC-18KX-02-026A	QK04-13300-MZ2	Main PCB	1
26-1	MSC-18KX-02-026.1	JK01-10113-100	3.15A Delay Fuse, D5 x 20mm	1
27	MSC-18KX-02-027	5202-00006-000	Nut, M6	8
28	MSC-18KX-02-028	5110-04004-000	Screw, M4 x 4mm	2
29	MSC-18KX-02-029	JK01-10010-000	Ground Terminal	1
30	MSC-18KX-02-030	JK01-JD000-000	Ground Label	1
31	MSC-18KX-02-031	QK06-10001-100	Bottom Plate	1
32	MSC-18KX-02-032	5301-00005-000	Flat Washer, D5	2
33	MSC-18KX-02-033	QK05-20006-H00	Battery Charger Indicator - Red	1
34	MSC-18KX-02-034	QK05-20005-H00	Battery Charger Indicator - Green	1
35	MSC-18KX-02-035	QK04-80002-FJ5	LED Lamp Socket, 12-24VDC	1
36	MSC-18KX-02-036	QK04-00015-000	LED Lamp Cable, Red / Black	1
37	MSC-18KX-02-037	QK04-50700-M00	Cable XS1, 11.8+	1
38	MSC-18KX-02-038	JK01-00004-000	Cable Nut, M20	2
39	MSC-18KX-02-039	QK04-50800-M00	Cable XS7, 3.9+	1
40	MSC-18KX-02-040	DJ02-00007-000	Cable Nut, M25	1
41	MSC-18KX-02-041	QK04-00013-M00	Battery Indicator Cable, 53+	1
42	MSC-18KX-02-042	QK04-30100-M00	Control Panel Cable, 25.6+	1
43	MSC-18KX-02-043	JK01-00008-000	Alarm Buzzer (Motor Contactor Fault)	1

Power Unit Assembly

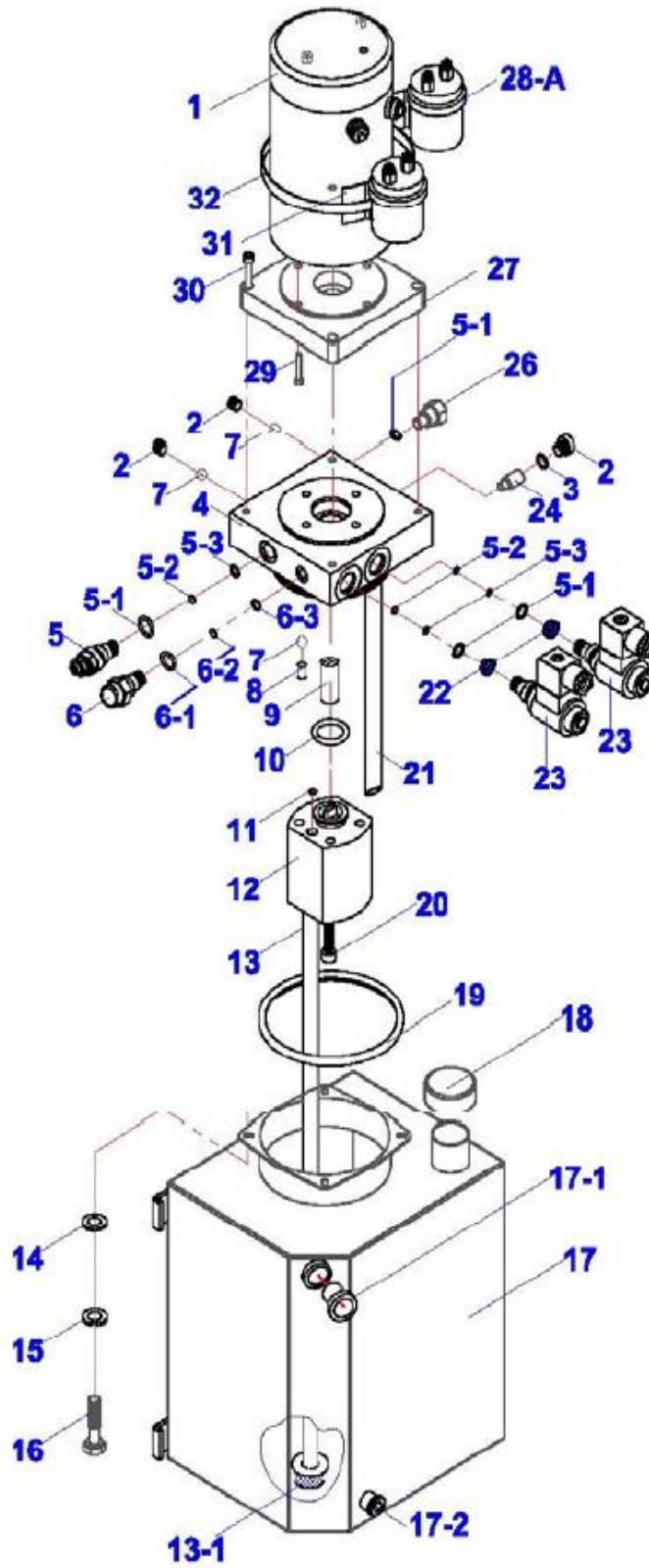

Drawing #3

Power Unit Assembly Parts List

ITEM	Tux P/N	M-Ref P/N	DESCRIPTION	QTY
1	MSC-18KX-03-001	BZ22-05001-300	DC Motor, 24VDC, 3KW, 125A	1
2	MSC-18KX-03-002	BZ01-04008-000	Close Nut, 9/16-18 UNF	1
3	MSC-18KX-03-003	5901-00118-000	O-Ring, D11.8 x D1.8	1
4	MSC-18KX-03-004	BZ22-04001-F00	Valve Block	1
5	MSC-18KX-03-005	BZ20-04002-000	Overflow Valve, 25Mpa	1
5-1	MSC-18KX-03-005.1	5901-00160-000	O-Ring, D16 x D2	4
5-2	MSC-18KX-03-005.2	5901-00125-000	Circlip, D12 x 1.5mm	3
5-3	MSC-18KX-03-005.3	5901-00095-000	O-Ring, D9.5 x D1.8	3
6	MSC-18KX-03-006	BZ20-04024-100	Main, Flow Control Valve	1
6-1	MSC-18KX-03-006.1	5901-00190-000	O-Ring, D19 x D2	1
6-2	MSC-18KX-03-006.2	5901-00130-000	Circlip, D13 x 1.5mm	1
6-3	MSC-18KX-03-006.3	5901-00130-000	O-Ring, D13 x D1.8	1
7	MSC-18KX-03-007	5601-00800-000	Steel Ball, D8	3
8	MSC-18KX-03-008	5109-10010-000	Threaded Pin, M10x1x10	3
9	MSC-18KX-03-009	BZ22-00003-B00	Connecting Rod, D20 x 34.5mm	1
10	MSC-18KX-03-010	5901-00277-000	O-Ring, D27.7 x D2.4	1
11	MSC-18KX-03-011	5901-00925-000	O-Ring, D9.25 x D1.78	1
12	MSC-18KX-03-012	BZ01-03000-F00	Gear Pump, 21Mpa	1
13	MSC-18KX-03-013	BZ20-01000-000	Suction Pipe, D18 x 350mm	1
13-1	MSC-18KX-03-013.1	BZ01-01002-000	Filter	1
14	MSC-18KX-03-014	5301-00006-000	Washer, D6	4
15	MSC-18KX-03-015	5303-00006-000	Elastic Washer, D6	4
16	MSC-18KX-03-016	5101-06012-000	Bolt, M6 x 12mm	4
17	MSC-18KX-03-017	BZ20-02100-300	Oil Tank	1
17-1	MSC-18KX-03-017.1	DJ02-00042-000	Fluid Level Indicator	1
17-2	MSC-18KX-03-017.2	BZ20-02101-000	Outlet Plug, M12 x 10mm	1
18	MSC-18KX-03-018	BZ20-02200-000	Tank Cover	1
19	MSC-18KX-03-019	5901-01120-000	O-Ring, D112 x D3.55	1
20	MSC-18KX-03-020	5105-08080-000	Screw, M8 x 80mm	2
21	MSC-18KX-03-021	BZ20-00001-000	Return Pipe, D10 x 260mm	2
22	MSC-18KX-03-022	BZ01-04011-000	Oil Filter	2
23	MSC-18KX-03-023	BZ13-04100-000	Solenoid Release Valve, 24VDC	2
24	MSC-18KX-03-024	BZ20-04026-000	Sub, Flow Control Valve	1
26	MSC-18KX-03-026	BZ20-04007-000	Check Valve	1
27	MSC-18KX-03-027	BZ22-05008-B00	Motor Adaptor Plate	1
28-A	MSC-18KX-03-028A	BZ22-05002-002A	Unipolar DC Contactor, 24VDC, 200A	2
29	MSC-18KX-03-029	5105-05030-000	Screw, M5 x 30mm	4
30	MSC-18KX-03-030	5105-06025-000	Screw, M6 x 25mm	4
31	MSC-18KX-03-031	BZ22-05003-000	Contactor Support	2
32	MSC-18KX-03-032	BZ01-00002-000	Metal Clamp	1

LIMITED WARRANTY

Structural Warranty:

The following parts and structural components carry a five year warranty:

Columns	Arms	Uprights	Swivel Pins
Legs	Carriages	Overhead Beam	
Tracks	Cross Rails	Top Rail Beam	

Limited One-Year Warranty:

Tuxedo Distributors, LLC (iDEAL) offers a limited one-year warranty to the original purchaser of Lifts and Wheel Service equipment in the United States and Canada. Tuxedo will replace, without charge, any part found defective in materials or workmanship under normal use, for a period of one year after purchase. The purchaser is responsible for all shipping charges. This warranty does not apply to equipment that has been improperly installed or altered or that has not been operated or maintained according to specifications.

Other Limitations:

This warranty does not cover:

1. Parts needed for normal maintenance
2. Wear parts, including but not limited to cables, slider blocks, chains, rubber pads and pulleys
3. Replacement of lift and tire changer cylinders after the first 30 days. A seal kit and installation instructions will be sent for repairs thereafter.
4. On-site labor

Upon receipt, the customer must visually inspect the equipment for any potential freight damage before signing clear on the shipping receipt. Freight damage is not considered a warranty issue and therefore must be noted for any potential recovery with the shipping company.

The customer is required to notify Tuxedo of any missing parts within 72 hours. Timely notification must be received to be covered under warranty.

Tuxedo will replace any defective part under warranty at no charge as soon as such parts become available from the manufacturer. No guarantee is given as to the immediate availability of replacement parts.

Tuxedo reserves the right to make improvements and/or design changes to its lifts without any obligation to previously sold, assembled or fabricated equipment.

There is no other express warranty on the Tuxedo lifts and this warranty is exclusive of and in lieu of all other warranties, expressed or implied, including all warranties of merchantability and fitness for a particular purpose.

To the fullest extent allowed by law, Tuxedo shall not be liable for loss of use, cost of cover, lost profits, inconvenience, lost time, commercial loss or other incidental or consequential damages.

This Limited Warranty is granted to the original purchaser only and is not transferable or assignable.

Some states do not allow exclusion or limitation of consequential damages or how long an implied warranty lasts, so the above limitations and exclusions may not apply. This warranty gives you specific legal rights and you may have other rights, which may vary from state to state.

8320 E Hwy 67, Alvarado, TX 76009
Ph 817-558-9337 / Fax 817-558-9740